



INSTRUCTION MANUAL

UMP3T-1

With MICRO2T SMARTouch™ Controller

CONTENTS

ABOUT THIS MANUAL	1
INTRODUCTION	2
Notes and Warnings.....	2
UMP3	2
UMP3/MICRO2T Parts List.....	4
Unpacking.....	4
INSTRUMENT DESCRIPTION	5
UMP3 Description.....	5
MICRO2T Description.....	5
UMP3 Description.....	8
Setting Up the System	9
Choosing a Syringe	11
Setting Parameters.....	14
Selecting System Options	22
Defining a Custom Syringe for Use with the UMP3.....	24
OPERATING INSTRUCTIONS.....	27
Sending Commands to a Pump	28
Placing a Syringe Before Delivery.....	28
Calibrating a Syringe.....	29
Sample Operational Preparations	30
Grouped Operations.....	33
Computer Control.....	34
MAINTENANCE	37
Cleaning.....	37
ACCESSORIES.....	37
Syringes	37
Additional Accessories.....	39
Replacement Parts	39
TROUBLESHOOTING	40
SPECIFICATIONS.....	42
APPENDIX A: USING TEFLON TIPPED SYRINGES.....	44
DECLARATION OF CONFORMITY	45
INDEX.....	48
WARRANTY	50
Claims and Returns	50
Repairs.....	50



ABOUT THIS MANUAL

The following symbols are used in this guide:



This symbol indicates a CAUTION. Cautions warn against actions that can cause damage to equipment. Please read these carefully.



This symbol indicates a WARNING. Warnings alert you to actions that can cause personal injury or pose a physical threat. Please read these carefully.

NOTES and TIPS contain helpful information.





Fig. 1—The MICRO2T SMARTouch™ controller is a touch screen controller for use with the UMP3 and Nanoliter series pumps. The UMP3 shown here is mounted on WPI's M3301 micromanipulator and TB-1 stand (not included). Mounted on the UMP3 is our signature NanoFil™ syringe (not included).

INTRODUCTION

WPI's SMARTouch™ controller may be used with the **UltraMicroPump III (UMP3)** syringe pump or the **Nanoliter 2020** positive displacement pump. This manual will describe the use of the **UMP3** and the **Nanoliter 2020** pumps with the **SMARTouch™** controller.

Notes and Warnings

 **CAUTION:** DO NOT operate the UMP3 until you have programmed your end-stop position on the MICRO2T controller. Failure to do so will result in mechanically jamming the UMP3.

 **CAUTION:** Do not apply solvents or oils to any part of the **UMP3**. For **Nanoliter 2020**, oil should only be present in the micropipette

 **CAUTION:** The **UMP3**, **Nanoliter 2020** and **MICRO2T** are not autoclavable. Sterilize with EtO or by wiping the exterior of the pumps and controller with alcohol or Cidex (WPI# **7364-4**).

 **CAUTION:** Do not disassemble. There are no serviceable parts inside either the pumps (**UMP3** or the **Nanoliter 2020**) or the **MICRO2T** controller. Attempting to manipulate the devices in any way may cause damage to your units or short them out. Contact a WPI expert to set-up maintenance, if needed.

 **CAUTION:** Always hold **UMP3** by the main body or mounting bar. Do not swing or carry the **UMP3** by its cable.

 **CAUTION:** Use of gas-tight syringes on the **UMP3** is not recommended for syringes above 250µL as this can damage the motor, due to excessive drive force. Please use liquid-tight syringes for applications that require volumes greater than 250µL.

 **CAUTION:** Do not attempt to inject more fluid volume than is in the syringe. This can damage the syringe and seize the pump.

 **CAUTION:** Do not wash or lubricate the pump heads.

UMP3

The **UMP3** uses microsyringes to dispense low-volume samples, per unit of X nanoliter (nL)/Y minutes. Microsyringes are easily installed by placing the syringe barrel into the UMP3's clamps. **UMP3** accepts syringes from 0.5µL to 250µL (minimum O.D. 5.5mm - maximum O.D. 9mm).

With its touch screen controller, **MICRO2T**, this versatile injection system can be useful for a wide range of applications including micro delivery of biochemical agents

or dyes, and both *in-* and *ex-vivo* injection. The **UMP3** can be mounted directly onto a stereotaxic frame or micromanipulator.

Operating parameters for the **UMP3** are set with the **MICRO2T**, and must be programmed prior to use. Up to two pumps may be independently controlled. User-defined operating parameters are stored in memory for instant recall when the unit is powered on.

An optional foot switch (WPI# 15867) can be plugged into a 3.5mm connector on the rear of the controller for hands free start /stop operation.

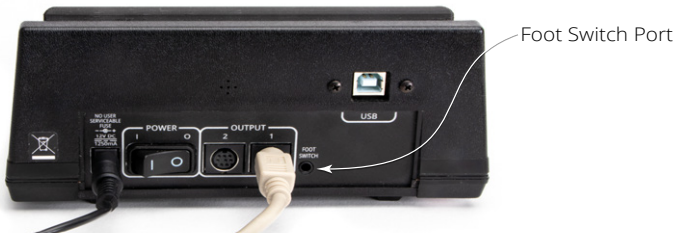

Fig. 2—The port for the footswitch is located on the rear panel of the MICRO2T controller.

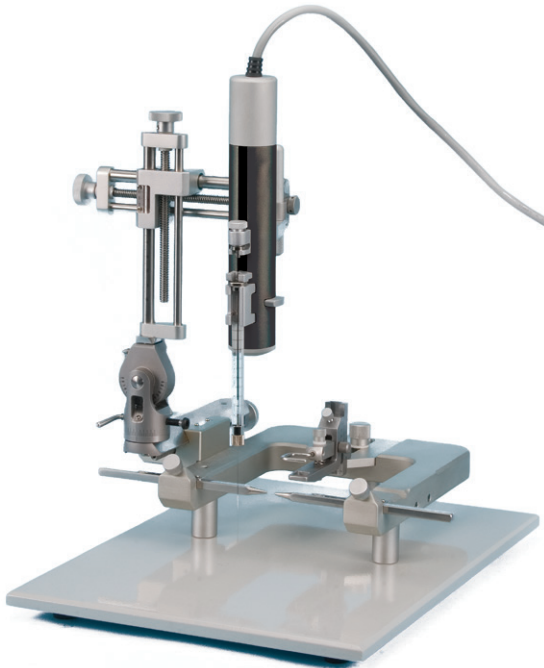

Fig. 3—UMP3 is shown mounted to stereotaxic frame (not included).

UMP3/MICRO2T Parts List

After unpacking, verify that there is no visible damage to the instrument. Verify that all items are included:

- (1) **UMP3** UltraMicroPump 3
- (1) **MICRO2T** 2-Channel Controller
- (1) Accessory Kit, including:
 - 12V Power Supply
 - Power Cable
 - Phillips screwdriver #0
- (1) Instruction Manual

NOTE: If an **UMP3** is ordered alone, it does not include the **MICRO2T** Controller. The kits (**UMP3-1**, **UMP3-2**) include a controller. **UMP3-1** includes one **UMP3** pump, **UMP3-2** includes 2.

For a list of microsyringes available from WPI, see "Syringes" on page 37.

Unpacking

Upon receipt of this instrument, make a thorough inspection of the contents and check for possible damage. Missing cartons or obvious damage to cartons should be noted on the delivery receipt before signing. Concealed damage should be reported at once to the carrier and an inspection requested. Please read the section entitled "Claims and Returns" on page 50 of this manual. Please contact WPI Customer Service if any parts are missing at 941.371.1003 or customerservice@wpiinc.com.

Returns: Do not return any goods to WPI without obtaining prior approval (RMA # required) and instructions from WPI's Returns Department. Goods returned (unauthorized) by collect freight may be refused. If a return shipment is necessary, use the original container, if possible. If the original container is not available, use a suitable substitute that is rigid and of adequate size. Wrap the instrument in paper or plastic surrounded with at least 100mm (four inches) of shock absorbing material. For further details, please read the section entitled "Claims and Returns" on page 50 of this manual.

INSTRUMENT DESCRIPTION

UMP3 Description



Fig. 4—System picture of the UMP3 with the controller. A typical setup includes a micromanipulator, a base stand and a syringe, which are not included.

MICRO2T Description

The MICRO2T is used to control one or two UMP3 syringe pump or Nanoliter 2020 positive displacement pumps.



Fig. 5—The MICRO2T touch screen controller shows the command screen.

Pump Information Display Showing Two Pumps

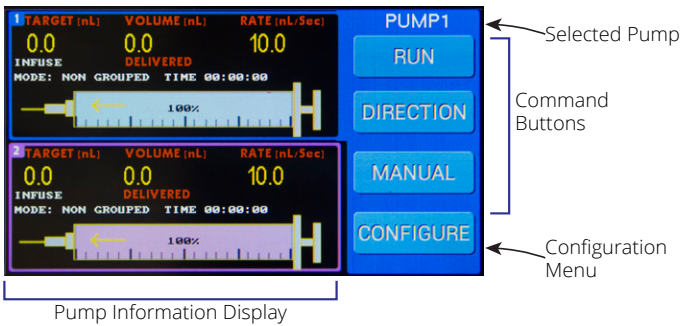

Fig. 6—The Command screen provides options for setting your inject/withdraw parameters per channel and allowing for the precise toggling of your selected pump(s).

Selected Pump—Touch one of the pump channels in the Pump Information Display area to select a channel. The upper channel is channel 1, and the lower is channel 2. The selected channel may be controlled using the command buttons or setup using the *Configure* button.

Command Buttons—The three command buttons (Run, Direction, and Manual) are used to control the selected pump (or pumps if they are grouped).

- **Run** starts the programmed sequence for the selected pump. The syringe delivery progression displays after you select Run on the controller display. While the pump is running, the border of the selected channel flashes to indicate which pump is running. As soon as you press *Run*, the button changes to *Stop* and the *Direction* button changes to *Pause*. To pause a running delivery sequence, press *Pause*. The button changes to *Resume*, and the *Stop* button changes to *Reset*. Press the *Resume* button and the delivery sequence will finish the programmed volume delivery. The ongoing delivery can be paused as many times as needed until the delivery is complete. To stop a delivery and reset the program, press *Reset*. The volume will be reset to zero and the unit will be ready for a new run. Be sure to verify your end-stop(s) are set before proceeding.
- **Direction** toggles the direction of the selected pump between infuse and withdraw. When the direction button is pressed, the selected pump's information display updates with the new direction of travel. A yellow arrow pointing toward the needle end of the syringe indicates infusion. A red arrow in the opposite direction indicates withdrawal.
- **Manual** mode allows you direct control of the selected pump. Press *Manual* to command the selected pump to travel in the direction and rate configured. Continuously press and hold the manual selection as long as you would like your pump to run, and, when you release the button, the pump stops.

Configuration Menu—Press *Configure* to access the Configuration screen for the selected pump. Parameters which may be set include the volume target, counter

mode, delivery rate, selected syringe, motor drive mode, units of delivery and grouping status. (See “Setting Parameters” on page 14.)

Pump Information Display—This area shows information about each pump connected to the controller.

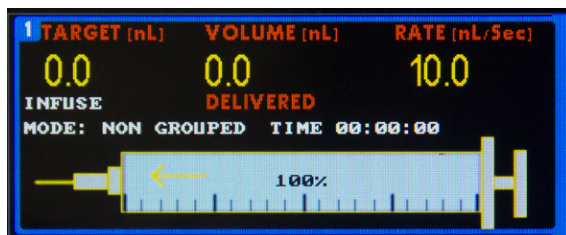

Fig. 7—The pump display shows information for each programmed pump attached to the controller.

Command screen (Fig. 7) shows:

- Pump number in the upper left corner
- Grouped status. When grouped, a G appears next to the target volume. If it is not grouped, the G disappears.
- Target volume for dispensing (nL)
- Counter showing the volume dispensed or volume remaining in the syringe (nL)
- Rate (nL/sec or nL/min)
- Infuse or Withdraw mode
- Indicator showing the volume that has been delivered, or alternatively, the volume remaining. When Delivered is displayed, the volume counter increases during injection, and when Remaining is displayed, the volume counter decreases during injection
- Delivered volume (nL)
- Mode: Grouped, Non-grouped, Disabled can be toggled on the 2-channel display
- Time (hr:mm:sec) pump has run
- A diagram of the syringe shows the percentage of volume in the syringe
- Counter Mode: Delivered volume or volume remaining to be delivered

TIP: On the MICRO2T, use the Navigation function if you need to place a syringe in a specific position before an actual volume delivery. The Navigation feature is accessed by pressing the MICRO2T display for 2 seconds. See “Placing a Syringe Before Delivery” on page 28.

NOTE: When pumps are not grouped, they can be operated independently. While one pump is running, the remaining pump can be made active and used with separate parameters.

Back Panel of MICRO2T

The back of the MICRO2T has all the electrical connection ports and the power switch.

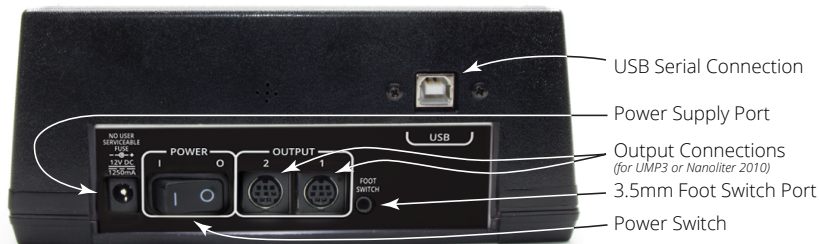

Fig. 8—The rear panel of the MICRO2T controller has the power switch and the connection ports for power, pumps, foot switch and computer control via USB.

UMP3 Description

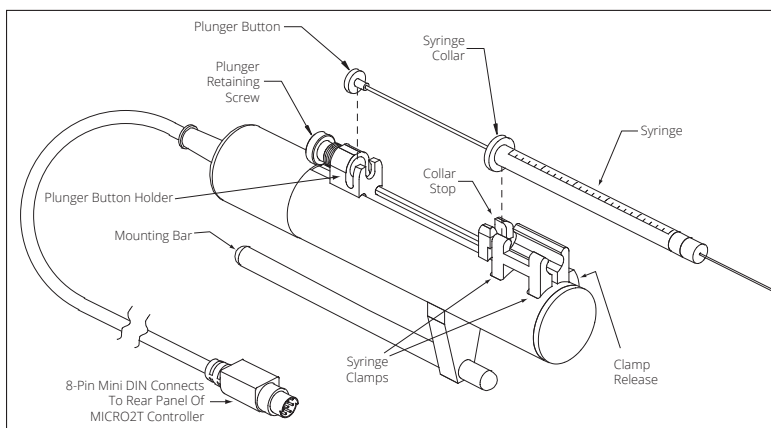

Fig. 9—The parts of the pump are labeled

Collar Stop—The syringe fits into the Syringe Clamp so that the Syringe Collar fits snugly against the Collar Stop. Always check the Collar Stop to verify that the syringe is held firmly.

Default position is for WPI NanoFil syringe collar. If necessary, adjust the collar stop placement using the Phillips head screw. Adjustment allows for ease of removal without damage to glass syringes.

Syringe Clamps hold the syringe.

Clamp Release—Press the Clamp Release Button to open the Syringe Clamps. To close the Syringe Clamps, carefully release the Clamp Release Button.

Plunger Button Holder—The Plunger Button on the syringe fits into the Plunger Button Holder.

Plunger Retaining Screw—Tighten the Plunger Retaining Screw to hold the Plunger Button in place. Do NOT overtighten. The Plunger Retaining Screw should only be finger-tight. Ensure the plunger is vertical and aligned with the syringe body. An off-axis plunger will result in damage to the plunger piston.

Mounting Bar—This rod is used for mounting the pump to a stereotaxic frame or a micromanipulator.

Cable Connector—Plug the Cable Connector into the rear panel of the **MICRO2T** Controller.

Phillip-Head Screw—This screw is used for collar stop adjustment. See “Collar Stop Adjustment” on page 10

Setting Up the System

1. Mounting the Pump

The **UMP3** can be mounted directly onto a stereotaxic frame or a micromanipulator, using the mounting bar (Fig. 9). The mounting bar may be repositioned, if necessary. There are two positions available on the **UMP3** body (Fig. 10).

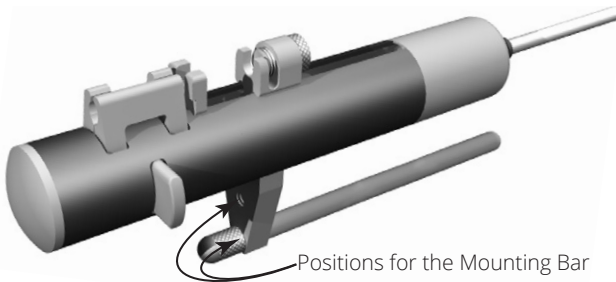

Fig. 10—Unscrew the mounting rod to reposition it.

WPI's **UMP3** fits directly into most stereotaxic frames that accept standard probe or electrode holders. The **UMP3** mounting bar diameter is 7.90mm (0.311 in.). For example, **UMP3** fits directly into KOPF Standard 900 series frames (replacing of 1770 electrode holder).

2. Connecting the Controller

Plug the **UMP3** cable into one of the **Output** connection ports on the back of the **MICRO2T** controller (Fig. 8).

3. Connecting the Controller and Powering Up

1. Plug the power supply into the power supply port on the rear panel of the **MICRO2T** (Fig. 8).
NOTE: The switchable power supply included with the controller automatically senses input line voltage between 100 and 240 V and converts it to 12 V.
2. Connect the power cord to the power supply, and plug it into an electrical outlet.
3. If the foot switch (WPI# **13142**, not included) is needed, plug it into the foot switch port on the rear panel of the **MICRO2T** controller.
4. The power switch is located on the rear panel of the **MICRO2T**. Switch the **MICRO2T** on and verify that the LCD screen is illuminated.

IMPORTANT NOTE: Before operating a pump (**UMP3** or **Nanoliter 2020**), you must set the end of travel limits of the pump. When using a **UMP3**, you must also enter the parameters into the **MICRO2T** controller. See “Setting Pump End of Travel Limits for the UMP3” on page 17 and “Setting Parameters” on page 14.

4. Mounting the Syringe

Syringes may be filled manually before mounting in the **UMP3** or filled by using the withdraw function on the Pump Navigation screen. See “Placing a Syringe Before Delivery” on page 28.

1. Place the plunger button of the syringe into the plunger button holder (leaving the plunger retaining screw loose).
2. Then, place the syringe collar into the collar stop (Fig. 9).
NOTE: Be careful not to damage the syringe collar during this installation.
4. Gently tighten the plunger retaining screw so that the plunger button is secure when the pump is activated. This allows for zero volume error during pump operations.

Axial Needle Alignment

In order to maintain a good syringe-needle alignment (particularly along the same axis of the supporting bar), rotate the syringe body while placing it into the two clamps. This allows the syringe to seat properly and aligns it along the body of the pump for minimal slant offset. If the collar stop clamp is too tight or too loose, the syringe needle alignment may be inaccurate.

Collar Stop Adjustment

If the collar stop is too tight to allow the syringe collar to insert easily, adjust it.

1. Locate the Phillips-head adjustment screw for the collar stop. It is located immediately below and behind the collar stop, in the groove with the long drive screw. (See Fig. 11.)
NOTE: The plunger button holder may need to be retracted to access the adjustment screw.



Fig. 11—The UMP3 collar stop adjustment is located in the groove on top of the UMP3.

2. With the #0 Phillips screwdriver, loosen this screw slightly (about 0.5 to 1 mm) to allow for a thicker collar. If necessary, grasp the collar stop and wiggle it backwards to move it.
3. Once the stop is backed out, adjust for a tight fit so the syringe body does not move when placed into the holder.
4. Gently re-tighten the screw in the new position.

Choosing a Syringe

Choosing the most appropriate syringe for an injection with the **UMP3** is relatively straightforward. The **UMP3** pump effectively executes a series of very small discrete steps which are added together to equal the final volume of an injection. Because of this, volumetric error is minimized as the inside diameter of the syringe is reduced. For the greatest accuracy, choose a syringe with the smallest ratio of volume to scale length that is practical for the application. When choosing a syringe for the **UMP3**, keep these two rules in mind:

- Inject more than 5% of syringe volume—Choose the syringe to inject no less than 5% of its volume at one time. The overall accuracy of the syringe is usually no greater than $\pm 3\%$, and the syringe's internal diameter may deviate from location to location along the length of the syringe interior. For example, a 100 μL syringe may be used for injections on the **UMP3** to volumes of 5 μL (5000nL) and higher with high precision and repeatability. Expecting this 100 μL syringe to inject less than 1 μL may prove difficult.
- 10 Step Rule—The **MICRO2T-UMP3** system uses a stepper motor to move the syringe piston forward to inject the volume. It is best to allow the motor to step forward at least 10 steps to prevent volume errors when injecting. Step no less than 10-100 steps for an entire single injection. For example, when using a 10 μL syringe, a 1-step movement of the motor injects 0.5276nL. Two steps injects 1.055nL. This may or may not be acceptable as the total error may exceed 1nL or nearly 0.1%. In this case, two steps is probably not enough resolution to accurately control the volume. Using this 10-step rule,

the minimum acceptable injectable volume from this 10 μ L (10,000 nL) syringe is 0.5276nL \times 10 or 5.276nL.

NOTE: Each type of syringe yields a different value depending on its inside diameter and the volume per step. The **MICRO2T** calculates the minimum volume and displays it on the Syringe Selection screen. For more information on syringes, see “Syringe Types” on page 13.

To select a syringe or change a syringe type:

1. Select the appropriate pump channel by tapping the desired channel on the display.

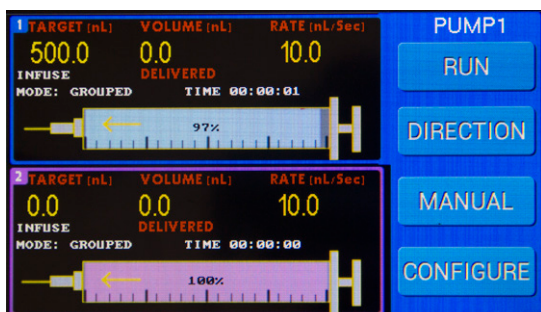

Fig. 12—Channel 1 is selected, and PUMP1 is shown with a blue background. When Channel 2 is selected the background turns pink.

2. Press the *Configure* button to access the Configuration screen for the selected channel.

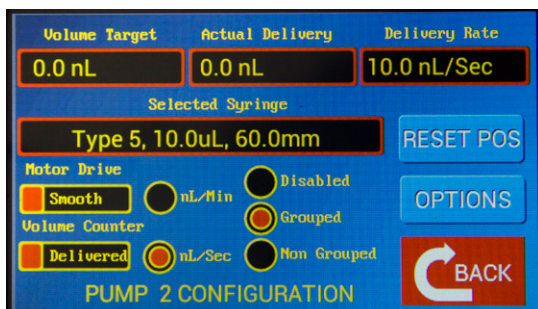

Fig. 13—The Configuration display shows the selected syringe type (Type 5) in the center of the screen.

3. Tap the *Selected Syringe* field to open the syringe selections screen for the active pump. The Syringe Selection screen displays the minimum recommended dispensable volume and the maximum injection rate.

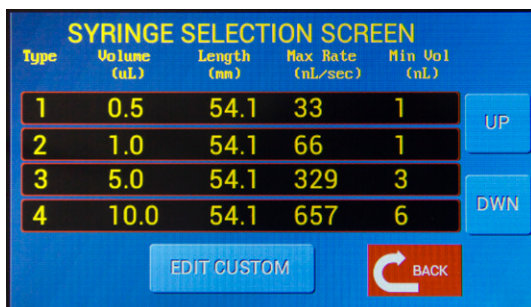

Fig. 14—The Syringe Selection screen allows you to choose from 10 default syringes and 3 user-defined syringes.

- Use the *Up* and *Dwn* buttons to scroll through the list of available syringes. The present selection is highlighted on the table. To select another syringe type, just touch the line corresponding to the desired syringe to highlight it. Then, it becomes the active selection. Then, press *Back* to save your selection. The syringe table has 9 syringe types. In addition, you may define three custom syringes. See “Defining a Custom Syringe for Use with the UMP3” on page 24.

Syringe Types

The volume per step and rate data for ten microsyringes are stored in **MICRO2T** controller’s memory. Three locations are available to store custom syringe parameters. See “Defining a Custom Syringe for Use with the UMP3” on page 24.

Type	Syringe Volume	Scale Length (mm)	ID (mm)	Max. Rate nL /sec	Minimum Volume (nL)
1	0.5 μ L	54.1	0.1085	33	1
2	1.0 μ L	54.1	0.1534	66	1
3**	5 μ L	54.1	0.343	329	3
4	10 μ L	54.1	0.485	657	6
5	10 μ L	60	0.4607	593	29
6	25 μ L	60	0.73	1482	66
7	50 μ L	60	1.03	2963	132
8	100 μ L	60	1.46	5927	265
9	250 μ L*	60	2.3	14817	659
NL	4.5 μ L†	25	0.48 plunger in 0.50 glass	644	6
A, B, C	User Defined			custom rate‡	
**	ILS005		0.4856		

* Gas-tight syringes are not recommended for **UMP3** volumes exceeding 250 μ L. Instead, use a liquid-tight syringe to prevent drive motor damage or stalling.

** The ILS005 5 μ L syringe must be defined as a custom syringe with a length of 28 mm.

† The NL syringe type is reserved for WPI’s **NANOLITER2020**, a nanoliter injector for the 2-70 nL range. It comes with its own simple controller, but may also be driven by the **MICRO2T**. For more information, see the **Nanoliter 2020 Instruction Manual**.

‡ The custom syringe rate maximum is calculated internally and is determined by the volume and length in relation to the maximum achievable motor speed.

Syringe Stroke Length

The delivery of the **UMP3** is based on 60 mm or 54.1 mm syringes. Please note which syringe length you are using. You may need to adjust the syringe length.

Maker	Syringe	Stroke Length	Use Type
WPI	NanoFil™ 10µL, 100µL	60 mm	5
Hamilton	1700 Series, 10µL	60 mm	5
Hamilton	700 Series 5 µL ,10 µL	54.1 mm	3, 4
Hamilton	7000 Series	60 mm	A, B, C*
SGE	0.5 µL – 10 µL	54.1 mm	1, 2, 3, 4
ILS 5 µL Luer tip	ILS005	28 mm	A, B, C
SGE, Hamilton 700, Hamilton1700	25 µL – 500 µL	60 mm	6-9

Not all syringes from a particular series or manufacturer are usable on the UMP3.*

The minimum delivered volume depends on the syringe size. The actual volume delivered is divisible by the volume per step. For example, using a syringe with a volume per step of 1nL, actual delivered volume for the given set volume is listed below.

Volume Set	Actual Volume Delivered
0-0.9999nL	0
1 nL-1.999nL	~1nL
2 nL-2.999nL	~2nL

Hamilton 7000 Series

Volume (µL)	ID (mm)	nL/Step	Type
0.5	0.1030	0.0265	User defined
1.0	0.1457	0.0529	User defined
2.0	0.2060	0.1058	User defined
5.0	0.3257	0.2645	User defined

Setting Parameters

Before using a **UMP3** pump with the SMARTouch™ controller, you must set the travel limits of the pump and of the syringe and define the program parameters. These are all defined from the Configuration screen for the selected pump. If you have multiple pumps, you will need to configure each one.

NOTE: All parameters are stored in memory, even when the controller is powered off.

Accessing the Configuration Screen

1. Select the appropriate pump channel on the Command screen by tapping the desired channel on the display.

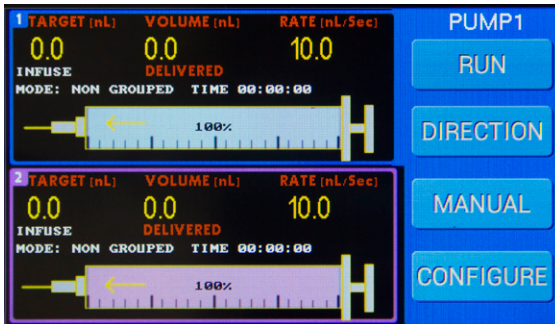

Fig. 15—Channel 1 is selected, and PUMP1 is shown with a blue field behind it in the upper right corner of the display screen.

2. Press *Configure* to access the Configuration screen for your pump.

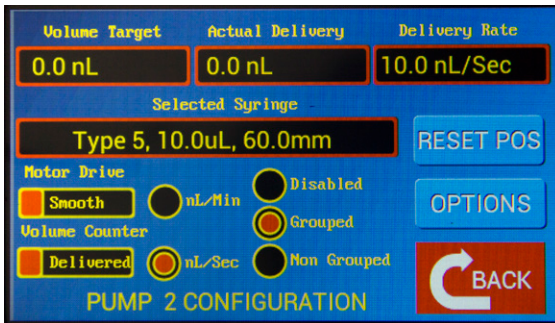

Fig. 16—The Configuration screen allows you to set the limits of travel and define parameters for a selected pump.

Calibrating the MICRO2T System Travel Limits

In order to minimize the human error and protect the **MICRO2T** and **UMP3** system and syringes from possible damage, the controller lets you define certain limits of travel for the pumps. You calibrate the travel limits. These limits are described as follows:

- **End Stop:** The *End Stop* calibration procedure sets the limit for the maximum distance that the UMP3's plunger carrier can travel in that direction. This setting prevents the motor from forcing the plunger carrier to the mechanical limit of the drive mechanism for an extended period of time, in the event the pump is left

running unattended. This prevents the possibility of binding the lead screw which can cause the pump to seize.

The calibration procedure involves using the **MICRO2T** controller to position the **UMP3** into the fully withdrawn position. Press and hold the *Set Stop* option on your **MICRO2T**. When released, the controller automatically performs the calibration.

The calibration should be checked:

- Every time a **UMP3** or **NANOLITER2020** is newly connected to a **MICRO2T** controller
- Any time a **UMP3** or **NANOLITER2020** is switched to a new channel that was not previously calibrated.
- Any time a pump is stalled due to excessive load or other accidental misuse.

Once the *End Stop* calibration is performed, it is not necessary to do it again, even if the pump is disconnected from the controller as long as it is re-connected to the same channel on the same controller.



CAUTION: IF YOU SUSPECT THAT THE PUMP HAS STALLED, CHECK THE END STOP CALIBRATION AGAIN.

- **Set Syringe:** The *Set Syringe* calibration defines the location of the maximum volume on the printed scale of the syringe. This calibration is performed with a syringe installed on the **UMP3** pump. It should be performed EVERY time a new syringe is installed onto the **UMP3**, unless the syringe is an identical model to that which was previously used. Use the controller to position the syringe plunger at its maximum withdrawn position, and then release to record the location in the software.

When these two calibrations (*End Stop* and *Set Syringe*) are performed, the plunger button holder (See Fig. 9.) of the **UMP3** is confined to a range of travel that is specific to your installed syringe. The plunger button holder is further prevented from being forcefully driven into the pump's mechanical limit in the withdrawn position. The procedure to perform each of these two calibrations follows.

Setting Pump End of Travel Limits for the UMP3

1. To access the Configuration screen, select a channel by tapping on the display from the Command screen. Then, click *Configure* for your selected pump. See “Accessing the Configuration Screen” on page 15.
2. Press *Reset Pos* to open the Syringe Stop Definition Screen.



Fig. 17—The Syringe Stop Definition screen lets you define the limits of travel for the pump.

3. Press *End Stop*. A warning message appears indicating that you are about to redefine the stops.

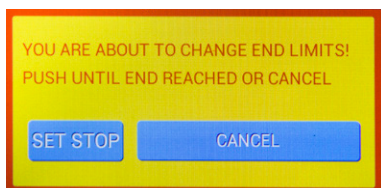

4. To set the new end stop position, press and hold the *Set Stop* button. The pump will continuously withdraw. Continue to press the button until the pump is driving against the mechanical end of travel. The **UMP3** emits a buzzing sound when it reaches its end of travel. You will not damage the pump by doing this. At this point release the button. The pump stops and retracts a short distance from the stop. The Syringe Stop Definition screen appears again, and the travel limits are stored.
5. Press *Back* to return to the Configuration screen. Press *Back* again to return to the Command screen.

Setting the Syringe Travel Limits (UMP3 Only)

Each syringe also has a travel limit that needs to be defined. This range will be inside the mechanical limits of the pump. To define the syringe limits, open the Syringe Stop Definition screen as we did when we were setting the travel limits for the pump.

1. To access the Configuration screen, select a pump by tapping on the display from the Command screen. Then, click *Configure* for your selected pump. See “Accessing the Configuration Screen” on page 15.
2. Tap *Reset Pos* to open the Syringe Stop Definition screen.



Fig. 18—The Syringe Stop Definition screen has four white navigation buttons used to position the syringe plunger when defining travel limits.

3. Use the four white navigation buttons to position the syringe plunger at the fully withdrawn position. This is the maximum scale reading for the syringe. From this menu, you may Inject or withdraw the pump at two different rates. (Fast and Slow).

	Withdraw	Infuse
Slow		
Fast		

4. Press *Back* to return to the Configuration screen without making any changes or press *Set Syringe* to store the new syringe travel limits. The Configuration screen appears again. The controller calculates the syringe limits based on the original length for the selected syringe type.
5. Press *Back* to return to the Command screen.

Resetting Limits after Power Failure

The **MICRO2T** records the location of all syringes when they stop. The information is recalled the next time the **MICRO2T** powers up. This allows the instrument to resume operation from the previous state without need to re-enter the syringe's position. If the **MICRO2T** is powered down while a volume delivery is taking place, the location at the time where power is removed is not recorded. However, the **MICRO2T** detects that this occurred and reminds you the next time the instrument is turned on. When you tap the startup screen to begin operation, the warning appears.

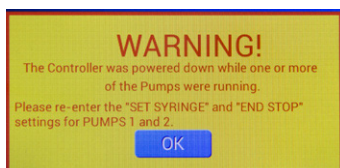

Fig. 19—This warning displays if the controller loses power while a pump is running.

Press **OK** to continue operation. The message indicates which pump or pumps require attention. Reset the end stop and syringe limits for the displayed pump or pumps. Until the limits are reset, the message continues to display on power up.

To reset the end stop, see “Setting Pump End of Travel Limits for the UMP3” on page 17. To reset the syringe limits, see “Setting the Syringe Travel Limits (UMP3 Only)” on page 17.

Defining Syringe Parameters

The syringe parameters are also set on the Configuration screen for your selected pump.

1. To access the Configuration screen, select a pump by tapping on the display from the Command screen. Then, click *Configure* for your selected pump. See “Accessing the Configuration Screen” on page 15.

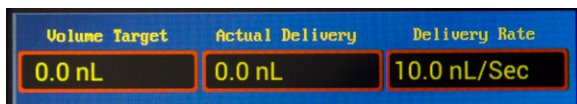

Fig. 20—The syringe parameters are shown across the top of the Configuration screen.

- **Volume Target** shows the volume in nanoliters that the pump is set to deliver. Whenever a parameter is changed, the controller calculates the actual volume that can be delivered.
- **Actual Delivery** is *read only and not directly editable*. The unit calculates the actual delivery volume to be as close as possible to the target volume based on the selected step microstepping and syringe size. This value changes to reflect the effects of changes to the target volume, syringe type and motor drive selection.
- **Delivery Rate** shows the rate at which the volume is dispensed by the pump. The unit for this parameter can be set to nL/sec or nL/min. The units are set by pressing the corresponding radio button on the Configuration screen. The units are updated on the text box as the unit is selected.

CAUTION: Syringe injection accuracy can vary. Since every syringe in the microliter volume range has its own unique intricacies, verify and calibrate each syringe and log its characteristics for accurate injections, depending on the syringe volume used. The **MICRO2T** controller has preset *types* of syringes to very accurately move the plunger button of the syringe a precise distance per injection.

- To update the volume target or the delivery rate, tap the text field. A keypad appears with 0.0 in the text field. Use the keypad to enter the desired value.

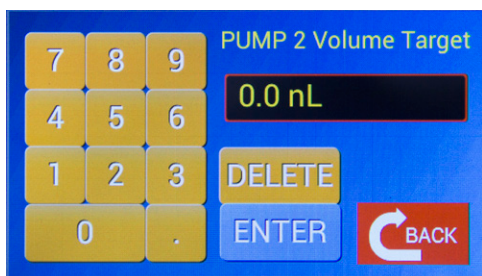

Fig. 21—Use the keypad to change the Volume Target. A similar keypad appears when you press the Volume Counter or the Delivery Rate fields.

TIP: If you enter an erroneous value, click *Delete* to clear it. Then, use the keypad to enter a new value.

- Press *Enter* to store the new value or press *Back* to return to the Configuration screen without saving any changes.

Defining Pump Parameters

The pump parameters define how the selected pump responds. These are set on the Configuration screen for the selected pump.

- To access the Configuration screen, select a pump by tapping on the display from the Command screen. Then, click *Configure* for your selected pump. See “Accessing the Configuration Screen” on page 15.

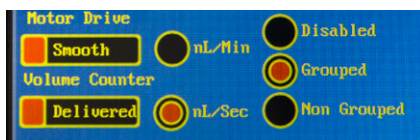

Fig. 22—The bottom left corner of the Configuration window shows pump parameters that may be set.

- Touch the control to select the **Motor Drive**. The control toggles between *Smooth* and *Max Load*. In order to simplify and to guarantee that the desired rate is achieved, the controller has two options to determine the amount of microstepping needed. The actual microstepping ratio is dependent on the selected syringe and the desired delivery rate.

Motor Drive lets you set the pump to deliver the aliquoted sample using the incremental volume needed for delivery with the selected delivery rate.

- Smooth* yields the smoothest delivery for the selected rate. It sets the pump to deliver the desired rate with the maximum range of microsteps. Depending on the rate and the syringe geometry, this ratio can change between 256 microsteps per step to full stepping

- *Max Load* yields a more pulsatile flow with increased delivery force. It allows the pump to deliver at the desired rate with the fewest number of microsteps per step.

Smooth Delivery	Max Load
<p>Smooth undesirable pressure pulses when injecting low-volume samples or for injections lasting for extended periods of time.</p> <p>*Improved precision and noise reduction over <i>Max Load</i>.</p> <p>When undesirable pressure pulsations are observed during injects at a low delivery rate, use a smooth delivery.</p>	<p>Increased delivery force: 15–30% increase over <i>Smooth Delivery</i>. For applications that demand maximum torque, such as when using a large volume syringe, choose <i>Max Load</i>.</p>

3. **Volume Counter** determines how the volume counter is affected when volume is delivered. Tap the control to toggle between *Delivered* and *Remaining*.
 - When the *Volume Counter* slider is set to *Delivered*, the volume counter increments when injecting and decrements when withdrawing. The volume count shown is the amount delivered.
 - When *Run* is pressed the counter resets to zero and increments. When the slider is set to *Remaining*, the volume counter decrements when injecting and increments when withdrawing. When *Run* is pressed the counter is set to the volume target and decrements. Negative values signify a withdrawal and positive indicate an infusion.
4. Tap on a round button to select the desired units. Choose between nL/sec and nL/min for the delivery rate.
5. Tap on a round button to select your mode. **Mode Buttons** determine the pump operating mode.
 - *Disabled*—The selected pump is disabled and will not operate. When you return to the Command screen, DISABLED appears over the selected channel.
 - *Grouped*—You can start and stop all grouped pumps simultaneously. See “Grouped Operations” on page 33. When *Grouped* is selected, both pumps (if present) are set to grouped mode.
 - *Non-Grouped*—Non-grouped pumps operate independently.

Selecting System Options

The System Options screen gives you immediate access to basic parameters for your operations. To access the System Options screen:

- Select *System Options* from the main menu, or
- From the Pump Configuration screen, press *Options*.

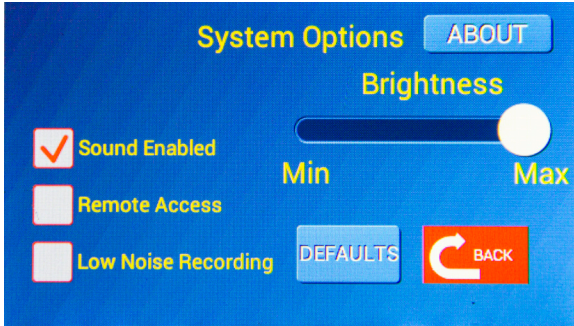

Fig. 23—The System Options screen allows you to set basic system parameters for operations. It also lets you revert to the factory default setup.

NOTE: Most parameters are stored in memory, even when the controller is powered off. However, when the unit is powered on, *Remote Access* is always disabled, and the pump drive motors are always enabled.

Disabling Sound Feedback

To disable all audio feedback from the **MICRO2T**, unselect the *Sound Enabled* check box. To re-enable the controller sounds, select the *Sound Enabled* check box. Press *Back* to save the setting and bring up the Command screen.

Enabling Remote (Computer) Access

Remote control of the **MICRO2T** is available through the USB port on the back of the controller using a terminal access program on a computer. Before the controller can receive commands from a computer, remote access must be enabled. By default, this is disabled. To enable remote access:

1. Select the *Remote Access* check box.
2. Press *Back* to save the setting and bring up the Main Menu.
3. Press *Display All Channels* to bring the Channel Data Display. Remote commands are only accepted while the unit is on this command screen.

Remote access is always disabled when the **MICRO2T** is powered up. If you power the unit off, you will need to reset this parameter in order to operate with remote access. See “Computer Control” on page 34.

Disabling Motors for Low Noise Recording

For applications where a low electrical noise environment is necessary, you may turn off the drive electronics to the motors until you need to use them. When you return to any other screen, the motors automatically re-enable themselves.

To disable the drive motors on the **UMP3** pumps, select the *Low Noise Recording* check box. When you press the Back button to return to the previous screen, a warning appears.



Fig. 24—Warning message appears to let you know that the motors will be re-engaged and the Low Noise Recording period will end.

Press *Yes* to re-enable the motors and return to the Command screen. Press *No* to remain on the System Options page without enabling the motors.

The drive motors are always enabled when the **MICRO2T** is powered up. The only time the motors are disabled is when the *Low Noise Recording* check box is selected and the System Options screen is displayed.

Setting Screen Brightness

You may adjust the brightness intensity of the unit's display by using the Brightness slider. The unit will always power up with the brightness set to maximum.

Resetting System Defaults

To reset the factory default settings, press *Defaults*. A message appears to confirm that you want to load the default settings.

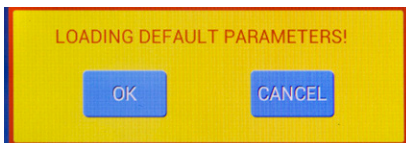

Fig. 25—Warning message appears indicating that you are about to reload the factory default settings.

Click *OK* to reload the factory defaults or *Cancel* to exit without loading the defaults. Press *Back* to bring up the main menu.

Displaying Firmware Revision

Press *About* to display the current firmware version running on the instrument. The *About* button appears in the upper right corner of the System Options screen. See Fig. 23.

Defining a Custom Syringe for Use with the UMP3

Ten microsyringes with volumes ranging from 0.5 μ L to 250 μ L are already preset in the **MICRO2T**. These include syringe types **1** through **9** and **NL** (for the **Nanoliter 2020**). See “Syringe Types” on page 13. A microsyringe with a volume other than those preset may be entered as syringe type **A**, **B** or **C**. To define a syringe, you only have to enter the volume and length of your syringe. The controller makes all the step calculations.

CAUTION: Ensure your syringe is primed prior to use. Dry threading, or movement of the plunger without introduction of fluid, will damage the integrity of your syringe.

To define a custom syringe type:

1. The **MICRO2T** has three memory locations for a custom syringe (A, B or C). The Syringe Selection screen is accessed from the Configuration screen. To open the Configuration screen for a pump, tap the appropriate pump channel on the display to select the pump. Then, press *Configure*. The Configuration screen for the selected channel appears.

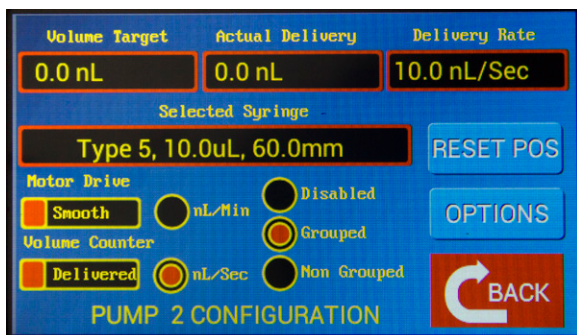

Fig. 26—The Configuration display shows the selected syringe type (Type 5) in the center of the screen.

2. Tap the *Selected Syringe* text field to open the Syringe Selections screen for the active pump. Use the *Up* and *Dwn* buttons to scroll to the customizable syringe types (A, B and C).



Fig. 27—You can define custom syringes using the Syringe Selection screen. Select one of the three user-defined syringe types—A, B or C.

3. Touch the syringe type you want to edit (A, B or C). This highlights the selected syringe. Click *Edit Custom* to open the Custom Syringe Definition screen.

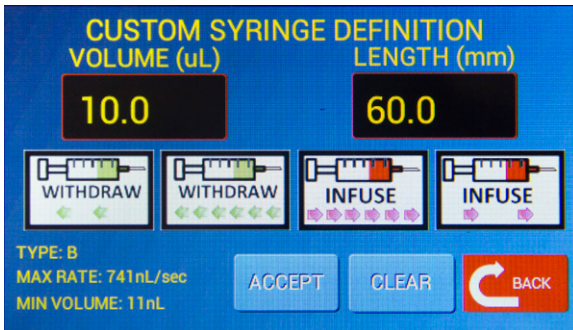

Fig. 28—Use the Custom Syringe Definition screen to define your new syringe type.

4. To modify the volume or length of the syringe, tap the corresponding selection, where a keypad will then appear. If you are unsure of the true length of your syringe, go to step 6.

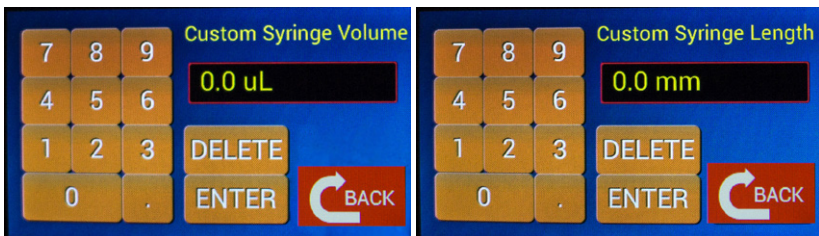

Fig. 29—Use the keypad to enter a new value for the selected syringe parameter.

-
5. Use the keypad to enter a new value for the selected syringe parameter.
 - Press *Enter* to save the value and return to the previous screen.
 - Press *Back* to return to the previous screen without saving the data.
 6. If you are unsure of the length of your syringe, use the direct measurement method. Rather than using the keypad to enter the syringe length value:
 - a. Place the syringe onto your **UMP3**.
 - b. Use the four white navigation buttons (*Slow Withdraw*, *Fast Withdraw*, *Fast Infuse*, *Slow Infuse*) on the Custom Syringe Definition screen (Fig. 28) to place the syringe plunger at the fully withdrawn position where the syringe scale reads its maximum value.
 - c. Press *Clear*. This sets the length to zero.
 - d. Use the navigation buttons to place the plunger at the zero reading on the scale. The scale length appears in the *Length* box. Press *Accept*.
 - e. Press *Back* to return to the Syringe Selection screen. The new length displays on the syringe description.
 7. Press *Back* to return to the Pump Configuration screen. Press *Back* again to return to the Command screen.

NOTE: Before using this option of volume delivery, set the syringe travel limits.

OPERATING INSTRUCTIONS

When the pump runs, an LED on the head of the **UMP3** illuminates to indicate that the pump is receiving a signal from the controller. As the pump runs, the counter increments as an indication of the plunger's motion.

NOTE: Before operating an **UMP3**, it is important to establish the limits of travel. See "Setting Pump End of Travel Limits for the UMP3" on page 17 and "Setting the Syringe Travel Limits (UMP3 Only)" on page 17.

This section provides information on using the **UMP3** with the **MICRO2T** controller.

- See "Sending Commands to a Pump" on page 28.
- See "Placing a Syringe Before Delivery" on page 28.
- See "Sample Operational Preparations" on page 30.
- See "Grouped Operations" on page 33.

The **MICRO2T** has a pump detection feature. When a **UMP3** is plugged into the controller, it is automatically detected. If no pump is plugged into the controller, the Command screen is blank for the missing pump (Fig. 30).

NOTE: Pump detection is not compatible with the legacy pump adapters used in earlier systems. For a **Nanoliter 2010** pump, when the NL syringe type is selected, the system will register the pump as present whether the injector is properly installed or not.

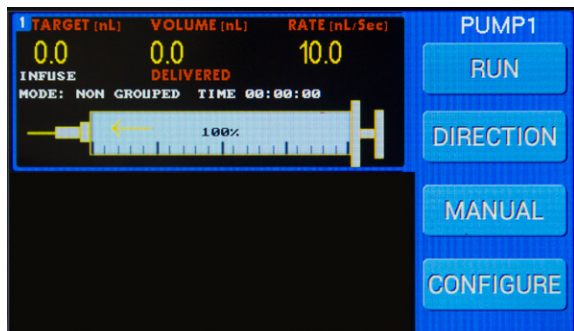

Fig. 30—Only one UMP3 pump is installed, so the second pump display is blank. In this example, Pump 1 is present and Pump 2 is absent. Note that a Nanoliter 2010 will always register as present, whether it is properly plugged in or not.

Sending Commands to a Pump



Fig. 31—Use the Command screen to control the pumps.

- *Run* starts the programmed sequence for the selected pump. As soon as you press *Run*, the button changes to *Stop* on a red background and the *Direction* button changes to *Pause*.
 - To pause a running delivery sequence, press *Pause*. The button changes to *Resume*. Press the button again, and the delivery sequence will finish the programmed volume delivery. The delivery can be paused again as many times as desired until the target volume is reached.
 - To stop a delivery and reset the program, press *Reset*. The delivery will be cancelled and the unit will be ready for a new delivery.

TIP: Make multiple injections by pressing *Run* again after the pump has stopped.

- *Direction* defines the direction of the selected pump. The button toggles between *Infuse* and *Withdraw*. When the direction button is pressed, the selected pump's information display updates with the new direction of travel. A yellow arrow pointing in the infusing direction or a red arrow in the opposite direction are also displayed inside the syringe illustration.
- *Manual* gives you direct control of the selected pump. Press *Manual* to command the selected pump to travel in the direction and speed configured. When you release the button, the pump stops.

Placing a Syringe Before Delivery

Before beginning an operation, you may precisely position the syringe plunger on the pump. This is accomplished with the Navigation screen. To access the pump's Navigation screen, press the information display for the respective pump for more than 2 seconds. This allows you to navigate and place the syringe in a desired position before an actual volume delivery.

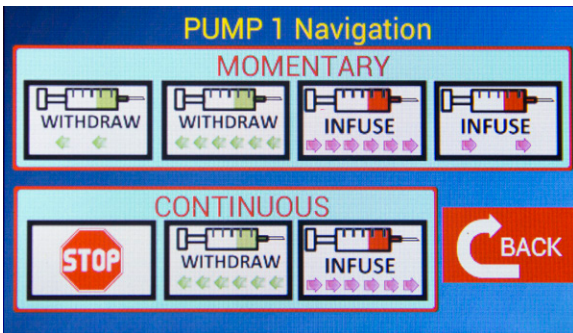

Fig. 32—The Navigation screen lets you manually position the syringe prior to a delivery. Use this screen to inject or withdraw the pump at two different rates. (Fast and Slow).

	Withdraw	Infuse
Slow		
Fast		

The movements can be momentary or continuous.

- Momentary movement lets you control the pump as long as you are pressing the button. When you stop pressing, the movement stops, too.
- In continuous mode, the pump continues to move until you press *Stop*.

Calibrating a Syringe

Every syringe should be calibrated on the pump that it is being used with.

Errors for micro volume syringes range from 1% to 3% of the full-scale volume. So, for a 10 μ L syringe injecting 10 μ L, there may be a maximum error of $\pm 0.3\mu$ L. When used with a specialized syringe pump like the **UMP3**, this same syringe is now defined by a fixed length and moved by a precision stepper motor. With this, great precision and repeatability can be achieved. This same 3% error of the 10 μ L syringe can now be calibrated to deliver a reduced error of $\pm 0.5\%$ tolerance or better. We will discuss a couple options for calibrating a syringe.

Volumetric Diameter Measurement Using Calibrated Scope

1. Using a microscope and a calibrated reticle or stage micrometer, inject water into a hydrated oil droplet
2. Using the reticle, measure the sphere.
3. Calculate the volume of the sphere ($V = [4/3] \times \pi r^3$) in nanoliters using the equation:
Volume = $(4/3) \times 3.1415926 \times (D/2)^3 \times 1000\text{nL/mm}^3$
D=Diameter in mm

Analytical Balance Measurement of Volume

1. Use an analytical balance to weigh the mass of an injected volume of water.
2. Calculate the volume in nanoliters. For pure water, 1g = 1mL at 4°C.

Calibration on the Pump

Once you have an accurate measurement of the dispensed volume, then you can make adjustments using one of the methods below.

- **Method 1:** Compare the injected volume with the actual volume. Then, adjust the volume injected accordingly.
- **Method 2 :** Use the A, B or C syringe type and enter the new volume and length. If the actual measured volume is 2.5% greater than commanded, the volume on the syringe custom definition would become $1.025 \times$ present volume. So a 10 μL syringe would become 10.25 μL .

NOTE: It may be necessary with some syringes to verify injections at different locations along the length of the syringe barrel because there can be variations along the inside length of the glass barrel.

Sample Operational Preparations

1. Set up the **UMP3** and connect it to the **MICRO2T**. See “Setting Up the System” on page 9.
2. (**UMP3 ONLY**) Check the fit and seating of the syringe on the **UMP3** pump head. See “Collar Stop Adjustment” on page 10 for the collar fit.
3. Turn on the **MICRO2T** using the power switch on the back panel.
4. Tap the introduction screen to access the main menu.

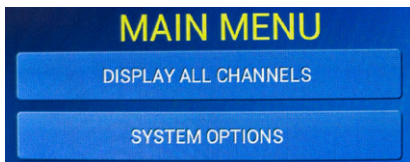

Fig. 33—From the main menu, you can open the Command screen or the System Options screen.

5. Select *Display All Channels* to open the Command screen.

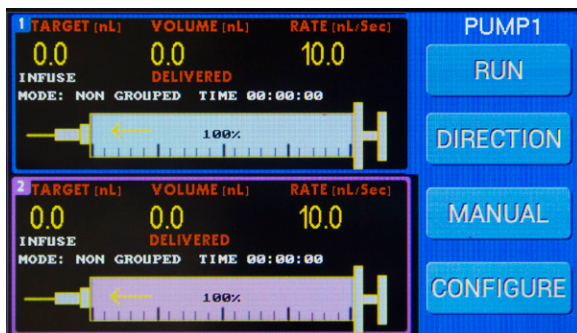

Fig. 34—The Command screen provides real time data on the connected pumps.

6. Select the desired pump by tapping the information display area for that pump. Then, press *Configure* to open the Configuration screen for the selected pump.

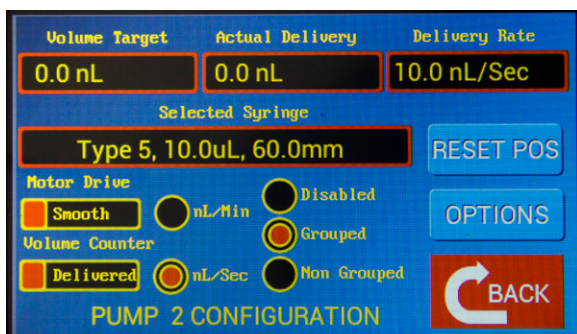

Fig. 35—Use the Configuration screen to enter all the parameters and select a syringe type.

7. Enter the volume you would like to dispense into the *Volume Target* field. Always enter the volume in nanoliters. Notice that the actual volume to be delivered appears in the center display field called *Actual Delivery*. Set the desired *Delivery Rate*. See “Resetting Limits after Power Failure” on page 18
8. Tap the *Selected Syringe* field to choose your *Syringe Type*. See “Choosing a Syringe” on page 11.
9. Tap the *Motor Drive* slider to select either *Smooth* or *Max Load*. *Smooth* sets the pump to deliver the desired rate with the maximum number of microsteps. *Max Load* allows the pump to deliver at the desired rate with the fewest number of microsteps per step. See “Defining Pump Parameters” on page 20.
10. Tap the *Volume Counter* slider to set the desired mode.
 - *Delivered* sets the volume counter to start at zero and increment toward the target volume.

- *Remaining starts at the target volume and decrements to zero.* See “Defining Pump Parameters” on page 20.
11. Use the round buttons to choose the delivery rate units, either *nL/min* or *nL/sec*.
 12. Disabled pumps will not display. Grouped pumps start and stop concurrently when any pump in the group is commanded. Non-grouped pumps operate independently when commanded. See “Defining Pump Parameters” on page 20.
 13. Press *Back* to return to the Command screen
 14. (**UMP3 ONLY**) Place a partially pre-filled syringe on the pump.
 15. (**UMP3 ONLY**) Press on the information display area for the selected pump to open the Pump Navigation screen. Position the plunger button holder to align and capture the syringe plunger without withdrawing any air into the needle tip. Press *Back* to return to the Command screen. See “Placing a Syringe Before Delivery” on page 28.

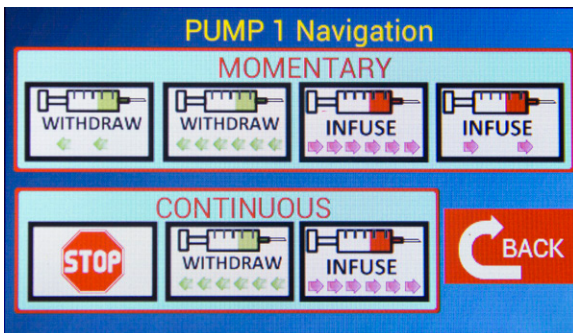

Fig. 36—Use the Pump Navigation screen to position the syringe plunger before delivery.

16. (**UMP3 ONLY**) Center the syringe plunger and tighten the carrier screw.
17. Expel some fluid to ensure that there is no air in the syringe needle. To do this, press *Infuse/Withdraw* until *Infuse* appears. Then, press *Manual* briefly.
18. Press *Run* to Infuse the required volume of fluid for the injection or for multiple injections. If you press *Configure* while the pump is running a message appears warning that the sequence has not completed. Other buttons are disabled while delivering a volume. Buttons are also disabled while the pump is paused. Press *NO* to complete the sequence or *YES* to stop the sequence and proceed to the Configuration screen.

NOTE: The controller will not allow the syringe to inject a volume greater than the filled volume in the syringe.

- When changing direction, we recommend traveling a minimum of three times the minimum recommended volume shown in the syringe selection screen for the selected syringe type. This ensures that the injection will deliver the desired volume when commanded.
- You are ready to begin.

NOTE: When pumps are not grouped, they can be operated independently. While one pump is running, the remaining pump can be made active and operated. The controls change to reflect the state of the active pump.

Grouped Operations

Pumps may be grouped so that they start and stop together. Commanding any grouped pump to *Run* initiates all the grouped pumps. However, the pump that is highlighted when the run command is issued becomes the master pump. The other pump is a slave.

- If the master pump reaches a mechanical limit before the delivery sequence completes, then the master and the slave pump stop. A short, high pitch tone is emitted when a mechanical limit is reached.
 - If a slave pump reaches a mechanical limit, that slave pump stops, and the master pump continues to run until it completes its sequence or until the master pump reaches a mechanical limit.
- Complete the operational preparations for each pump that will be grouped. Be sure to set one of the pumps to *Grouped* so that they can run simultaneously. See “Calibrating a Syringe” on page 29. Grouped pumps are marked on the Command screen.



Grouped pumps designation

Fig. 37—Grouped pumps are indicated on the Command screen.

- When you finish setting up the pump and syringe parameters, press *Back* to return to the Command screen.



Fig. 38—Pump 2 is the Master pump, and Pump 1 is the slave in this example.

- Press *Run* to infuse the required volume of fluid for the injection or for multiple injections. Both pumps will begin delivery of their sequences. Each pump will complete delivery of its sequence unless it reaches a mechanical limit or the master pump reaches a mechanical limit. If the master pump reaches a limit, all grouped pumps still infusing will stop.

Computer Control

Serial commands are used to control the **MICRO2T** via the serial port of a computer using a free USB port.

Serial Commands

All commands are case sensitive. The settings for the serial port are 9600 baud rate, 8 data bits, 1 start bit and 1 stop bit. Numbers and decimal points are indicated below by the “#” symbol. Enter a carriage return (Enter key on the keyboard) after each command.

Command	Syntax	Notes
Set target volume	V#####	##### - Desired Volume Target in nL. Value can be entered with or without decimal point (Range: 0 to 999999.9)
Set delivery rate	R#####	##### - Desired Delivery Rate in nL/sec or nL/min. Units are set with S and M commands. Value can be entered with or without decimal point (Range: 0 to 999999.9)
Set active pump to infuse direction	I	
Set active pump to withdraw direction	W	
Start delivery from stopped condition or resume from paused	G	

UMP3 with SMARTouch™ Controller

Command	Syntax	Notes
Halt volume delivery (STOP)	H	Cancels delivery in process
Pause delivery	U	Pauses delivery in process
Set delivery units to nL/sec	S	
Set delivery units to nL/min	M	
Set active pump	L#	# is between 1 and 2
Set mode to non-grouped	N	
Set mode to grouped	P	
Set mode to disabled	D	
Select syringe	T#	# is between 1 and 12. 1-9 for types 1-9, 10-12 for A, B and C.
Set motor drive to max load	BT	
Set motor drive to smooth	BS	
Set volume counter mode to Delivered	EN	
Set volume counter mode to Remaining	EI	
Display target volume	?V	Response: Target Volume = 10000.0nL OK
Display volume counter	?C	Response: Volume Counter = 1000.0µL OK
Display motor drive option	?B	Response: Smooth Drive (Max Load Drive) OK
Display motor counter mode	?E	Response: Delivered Volume (Remaining Volume) OK
Display pump mode	?M	Response: Mode: Non-Grouped (Mode: Grouped, Mode: Disabled) OK
Display syringe type	?S	Response: Type 8, 100.0uL, 60.0 OK
Display direction type	?D	Response: Direction: Infuse (Direction: Withdraw) OK
Display rate units	?U	Response: Rate Units: nL/min (Rate Units: nL/sec) OK
Display run mode	?G	Response: Motor State: Stopped (Motor State: Running, Motor State: Paused) OK
Pause script execution	A#####	##### is length of pause in seconds/100 Response: PAUSING (while in pause) OK (when finished pause)

Command	Syntax	Notes
Beep	F####	#### is length of beep in seconds/100 Response: BEEP (while beeping) OK (when finished beeping)
Kill command	Z	Ends current command and cancels any pending commands
Blocking start delivery	*G	Same as G command, but it stops accepting any new commands until the commanded delivery is finished at which point it responds with OK. This is useful when host computer wants to ensure delivery is finished before commanding another action.

MAINTENANCE

A **UMP3** requires minimal maintenance. Regular laboratory cleaning as per the recommendations in this manual will keep this instrument in optimum operating condition.

Cleaning

MICRO2T Controller—The controller may be wiped down with a damp cloth to remove any biohazardous material. Then, wipe it with a paper towel and isopropyl alcohol.

UMP3 Pump—Use a soft bristle brush dipped in 90% alcohol. Run the pump plunger back and forth, and brush any accumulated dust or particles off the drive screw and surface of the plunger carrier.

NOTE: Do not apply solvents or oils to any part of the **UMP3**.

Store the **UMP3** in a sealed plastic bag to prevent dust from accumulating on the drive screw. Excessive dust can cause jams and inadvertent stops.

ACCESSORIES

Syringes



UMP3 is designed to be used with glass syringes having barrel diameters from 5.5 to 9mm. WPI stocks the following syringes (with replaceable beveled needles):

Syringes with Beveled Needles

Order No.	Volume	Description	O.D. (mm)	Stroke length (mm)
NANOFIL	10 µL	100µL Fully Gastight System, 33-35G needles sold separately	6.4	60
NANOFIL-100	100 µL	100µL Fully Gastight System, 33-35G needles sold separately	7.75	60
SGE0005RN*	0.5 µL	0.5µL 23 ga (0.63 mm), 70mm long needle	8.0	54.1
SGE001RN*	1.0 µL	1.0µL 26 ga (0.47 mm), 70mm long needle	8.0	54.1
SGE005RN	5 µL	5µL 23 ga (0.63 mm), 50mm long needle	8.0	54.1
SGE025RN	25 µL	25µL 25 ga (0.50 mm), 50mm long needle	8.0	60
SGE050RN	50 µL	50µL 25 ga (0.50 mm), 50mm long needle	8.0	60
SGE100RN	100 µL	100µL 25 ga (0.50 mm), 50mm long needle	8.0	60

*The barrel length of this syringe is 17 cm long vs. 10 cm.

Replacement Needles

Order No.	Description
NF33BV/ NF33BL	For NanoFil™ Syringes, 33 ga BEVELED or BLUNT (40mm total fixture, injection needle length 10mm), 137mm total length installed within syringe barrel excluding plunger
NF34BV/ NF34BL	For NanoFil™ Syringes, 34 ga BEVELED or BLUNT (35mm total fixture, injection needle length 5mm), 127mm total length installed within syringe barrel excluding plunger
NF35BV/ NF35BL	For NanoFil™ Syringes, 35 ga BEVELED or BLUNT (35mm total fixture, injection needle length 5mm), 127mm total length installed within syringe barrel excluding plunger
NF36BV/ NF36BL	For NanoFil™ Syringes, 36 ga BEVELED or BLUNT (33mm total fixture, injection needle length 3mm), 125mm total length installed within syringe barrel excluding plunger
RN0005	For syringe SGE0005RN, 23 ga (0.63 mm) 70 mm long
RN001	For syringe SGE001RN, 26 ga (0.47 mm) 70 mm long
RN005	For syringe SGE005RN, 23 ga (0.63 mm) 50 mm long
RN025	For syringes SGE025RN, SGE050RN, SGE0100RN, 26 ga (0.47 mm) 50 mm long, 5-pack

Syringes with Luer Fitting (No Needle)

Order No.	Volume	Description	SCALE	
			O.D.	LENGTH
SGE050TLL	50µL	SGE 50µL Gas-tight Teflon Luer Lock	8.0 mm	60 mm
SGE100TLL	100µL	SGE 100µL Gas-tight Teflon Luer Lock	8.0 mm	60 mm
SGE250TLL	250µL	SGE 250µL Gas-tight Teflon Luer Lock	8.0 mm	60 mm

Use of gas-tight syringes above 250µL on the UMP3 is not recommended. Please use liquid-tight syringes for applications that require volumes greater than 250µL.

Hamilton is a trademark of Hamilton Co., SGE is a trademark of Scientific Glass Engineering, ILS is a trademark of Innovative Labor Systeme.

Additional Accessories

13142 Foot switch for **MICRO2T**

UMP3 UltraMicroPump 3

503301 Extension Cable for UMP3

Replacement Parts

300630 Mounting Bar, 4.3"

65085 Mounting Bar Locking Nut

65141 Plunger Retaining Screw

TROUBLESHOOTING

Issue	Possible Cause	Solution
Pump stalling. Motor can't push syringe plunger.	Needle blockage	The micropipette or the needle might be blocked by a tissue mass in or outside of the needle, or the needle tip may be too small for the programmed injection. Check for normal operation of the pump in air with and without the syringe attached. Too high a delivery rate through a tip that is too small can cause tissue damage and overtax the pump.
	Syringe misalignment	The syringe must be axially aligned to the UMP3 body in the clevises, and the syringe plunger button must be centered in its holder to properly inject along the length of the syringe. A small misalignment of the syringe plunger can cause pulsating waves in the injection and an incorrect amount of delivery.
	Mechanical damage	If the UMP3 plunger carrier is loose (a condition which can be caused by overtravel), the pump must be returned to WPI for repair.
Pump does not move when commanded	Selected pump is disabled or absent. End of travel in the selected direction will exceed the stops.	Make sure that the intended syringe is selected in the command screen by tapping the appropriate pump display area. Set the direction away from the end of travel if the syringe is at the stop.
Motor grinds; plunger does not travel.	Channel is improperly programmed	Test the pump in another channel, with the same program parameters.
Pump display is blank	Loose connection on a pump that's plugged in	Look for a loose connector at the rear of the MICRO2T , make sure the UMP3 plug is firmly seated. The gray plastic plug should be a flush fit with the connector on the controller. Verify that the pins in the connector are not damaged.

Issue	Possible Cause	Solution
Pump is jammed.	Plunger button has traveled to the extreme edge of the pump and has jammed	<ol style="list-style-type: none"> 1. Place the pump so that the syringe points to the right. 2. Remove the syringe. 3. Program the MICRO2T: Syringe style 7 (or larger to 9), 2000–5000nL volume, rate of ≥ 2000. 4. Press and hold the right or left arrow key for the direction you want the plunger holder to move in. Quickly tap <i>Manual</i> (Command screen) a couple times to unwind the drive screw tension and move the plunger holder away from the end of its travel. 5. Apply a slight pressure on the plunger carrier in the direction the pump is programmed to move. This can cause mechanical damage to the internal carrier if $>200g$ of force is used. <p>If the holder cannot be moved away from the stop end easily by this method, then contact techsupport@wpiinc.com for assistance. The pump may have to be returned for mechanical disassembly to correct this.</p>
Pump stalling. Motor can't push syringe plunger.	More than 400g is required to push the syringe plunger.	The syringe should not be a gas-tight (<i>i.e.</i> , Teflon-sealed) piston greater than 250 μ L in volume. This syringe type requires more force than the motor can push. If you require a large volume syringe (over 250 μ L), use a liquid-tight plunger.

NOTE: If you have a problem/issue that falls outside the definitions of this troubleshooting section, contact the WPI Technical Support team at (941) 371-1003 or technicalsupport@wpiinc.com.

SPECIFICATIONS

This unit conforms to the following specifications:

UMP3

Travel	62 mm
Minimum Dispensing Volume	0.58 nL/step (syringe dependent)
Linear Motion	6.35 µm/step
Plunger Position Error	< 0.5%
Pump Force	400 g
Syringe Diameters	5.5 to 9.0 mm
Maximum Step Rate	560 steps/sec (depending on syringe)
Weight	325 g (11.4 oz.)
Size	∅ 32 mm x 190 mm (∅ 1.3" x 7.5")
Power Requirements	12 VDC, provided by MICRO2T

MICRO2T Controller

Power Requirements	12 V (1.0 A)
Dimensions	12.7 x 15.2 x 8.9 cm (5 x 6 x 3.5")
Power Requirements. 12 VDC from auto-switchable power supply (100–240 VAC input)	

NanoFil Syringes

Syringe Order Code	Volume	Syringe Type	Syringe Body	Autoclavable/ Gas Sterilizable	Plunger Stroke Length	Plunger Cap Dimensions	Syringe Barrel I.D./O.D.*	Qty	MICRO4/ MICRO2T Syringe Type Selection
NANOFIL	10µL	Gas-tight	Borosilicate glass, Stainless Steel, PTFE	Yes ✓ 10°C/50°F to 80°C/176°F, 1000psig max pressure	60mm	O.D.*: 7.90mm (0.311in) Depth: 2.80mm (0.110in)	0.46mm (0.018in)/ 6.40mm (0.252in)	1 EA	L (MICRO4) 5 (MICRO2T)
NANOFIL-100	100µL						1.46mm (0.057in)/ 7.75mm (0.305in)	1 EA	

*I.D. = Inner diameter, O.D. = Outer diameter

NanoFil Needles

Order No.	Tip O.D.	Tip I.D.	Tip Length	Total Length	Shank O.D.	Bevel Length	Tip Material
NF33BV	210 µm	115 µm	10 mm	40 mm	460 µm	≈348 µm	Stainless Steel
NF34BV	185 µm	85 µm	5 mm	35 mm	460 µm	≈290 µm	Stainless Steel
NF35BV	135 µm	55 µm	5 mm	35 mm	460 µm	≈204 µm	Stainless Steel

Order No.	Tip O.D.	Tip I.D.	Tip Length	Total Length	Shank O.D.	Bevel Length	Tip Material
NF36BV	120 µm	35 µm	3 mm	33 mm	460 µm	≈156 µm	Stainless Steel
NFQ34-5	160 µm	100 µm	55 mm	75 mm	460 µm	n/a	Quartz
NF33BL	210 µm	115 µm	10 mm	40 mm	460 µm	0	Stainless Steel
NF34BL	185 µm	85 µm	5 mm	35 mm	460 µm	0	Stainless Steel
NF35BL	135 µm	55 µm	5 mm	35 mm	460 µm	0	Stainless Steel
NF36BL	120 µm	35 µm	3 mm	33 mm	460 µm	0	Stainless Steel
Silflex		100 µm		35 cm			
NF26BV	460 µm	140 µm		40 mm	460 µm		Stainless Steel

APPENDIX A: USING TEFLON TIPPED SYRINGES

Carefully remove the plunger and its Teflon tip by drawing it out of the syringe barrel.

1. Before inserting the plunger tip into the syringe, pre-wet the Teflon plunger tip and the syringe body interior with water.
-



CAUTION: Use care in inserting the plunger into the syringe, because the plunger rod may be easily bent.

2. Carefully place the plunger tip into the syringe and gently work the tip down into the body of the syringe using a thumb and forefinger to grasp and push small lengths of the plunger rod into the syringe. Repeat this procedure until the plunger tip is near the zero mark of the syringe.
3. Draw additional water into the syringe and slowly work the plunger up and down until the plunger tip is cold formed into the syringe and the stiffness goes away. The stiffness of the new plunger tip may require you to move the rod in small increments until the tip is formed enough to actuate by the rods full length.

DECLARATION OF CONFORMITY



WORLD PRECISION INSTRUMENTS, LLC.
Telephone: (941) 371-1003 Fax: (941) 377-5428
e-mail wpi@wpiinc.com

DECLARATION OF CONFORMITY CE

We: World Precision Instruments, Inc.
175 Sarasota Center Boulevard
Sarasota, FL 34240-9258, USA

as the manufacturer/distributor of the apparatus listed, declare under sole responsibility that the product(s):

MICRO2T (tested with UMP3)

To which this declaration relates is/are in conformity with the following standards or other normative documents:

Low Voltage Directive (Safety) 2014/35/EU:

- EN 61010-1:2010+A1:2019

EMC Directive 2014/30/EU:

- EN IEC 61326-1:2021
- EN IEC 61326-2-3:2021
- EN IEC 61000-3-2:2019+A1:2021
- EN IEC 61000-3-3:2013+A2:2021

Issued On: December 13, 2022

Cory Boyes / Director of Design and
Development

Europe Representative
Mr Andrew Waldes
Managing Director
World Precision Instruments Germany GmbH,
Pfingstweide 16, 61169 Friedberg, Germany

F-QC-006 Rev D



WORLD PRECISION INSTRUMENTS, LLC.
Telephone: (941) 371-1003 Fax: (941) 377-5428
e-mail wpi@wpiinc.com

DECLARATION OF CONFORMITY CE

We: World Precision Instruments, Inc.
175 Sarasota Center Boulevard
Sarasota, FL 34240-9258, USA

as the manufacturer/distributor of the apparatus listed, declare under sole responsibility that the product(s):

UMP3 (tested with MICRO2T)

To which this declaration relates is/are in conformity with the following standards or other normative documents:

Low Voltage Directive (Safety) 2014/35/EU:

- EN 61010-1:2010+A1:2019

EMC Directive 2014/30/EU:

- EN IEC 61326-1:2021
- EN IEC 61326-2-3:2021
- EN IEC 61000-3-2:2019+A1:2021
- EN IEC 61000-3-3:2013+A2:2021

Issued On: December 13, 2022



*Cory Boyes, Director of Design and
Development*

Europe Representative
Mr Andrew Waldes
Managing Director
World Precision Instruments Germany GmbH,
Pfungstweide 16, 61169 Friedberg, Germany

F-QC-006 Rev D



WORLD PRECISION INSTRUMENTS, LLC.
Telephone: (941) 371-1003 Fax: (941) 377-5428
e-mail wpi@wpiinc.com

DECLARATION OF CONFORMITY CE

We: World Precision Instruments, Inc.
175 Sarasota Center Boulevard
Sarasota, FL 34240-9258, USA

as the manufacturer/distributor of the apparatus listed, declare under sole responsibility that the product(s):

NANOLITER 2020

To which this declaration relates is/are in conformity with the following standards or other normative documents:

Low Voltage Directive (Safety) 2014/35/EU:

- EN 61010-1:2010+A1:2019

EMC Directive 2014/30/EU:

- EN IEC 61326-1:2021
- EN IEC 61326-2-3:2021
- EN IEC 61000-3-2:2019+A1:2021
- EN IEC 61000-3-3:2013+A2:2021

Issued On: December 13, 2022

Cory Boyes, Director of Design and
Development

Europe Representative
Mr Andrew Waldes
Managing Director
World Precision Instruments Germany GmbH,
Pfungstweide 16, 61169 Friedberg, Germany

F-QC-006 Rev D

INDEX

Symbols

13142 39
65085 39
65141 39
300630 39

A

Accessory Kit 4
actual delivery 19
alignment 10
analytical balance 30
audio feedback 22
autoclavable 2
autoclave 2
axial needle alignment 10

B

blockage 40
brightness intensity 23

C

cable connector 9
calibrate 19, 29
calibrating a syringe 29
Cidex 2
clamp release 8
collar stop 8, 10
collar stop clamp 10
Command buttons 6
Command screen
6, 7, 15
computer control 34
Configuration menu 6
Configuration screen
15, 19
connecting the controller
9
counter 7
counter mode 7
custom syringe 24

D

delivered volume 7
delivery rate 19
direction 6, 28
disabled 21
disable motors 23
disassemble 2

E

End Stop calibration 15
error 11

F

firmware version 23
foot switch 3, 10

G

gas-tight syringes
2, 13, 38, 41
group 21
grouped operations 33
group pumps 7, 32

H

Hamilton 38
Hamilton 7000 series
syringes 14
hydrated oil droplet 30

I

infuse 28

J

jam 41

L

liquid-tight syringe 41
liquid-tight syringes 2, 38
low noise recording 23

M

manual 28
max load 20
MICRO2T 5
micrometer 30
misalignment 40
motor drive 20, 31
motors, disable 23
mounting a syringe 10
mounting bar 9
mounting the pump 9

N

Nanoliter 2010 description
9
Navigation screen 28
non-group 21

O

oil 2

P

parameters, setting 14
parts list 4
pause 28
plunger button holder 9
plunger carrier 40
plunger retaining screw
9, 10
power failure 18
power supply 10
pulsations 21
pump detection 27
Pump Information Display
6
pump parameters 20

R

remote control 22, 34
Reset Pos 17
resume 28
reticle 30
returns 4
RN001 38
RN0005 38
RN025 38
run 6, 28

S

- screen brightness 23
- sending commands 28
- serial commands 34
- set syringe 16
- SGE 38
- SGE001RN 37
- SGE0005RN 37
- SGE025RN 37
- SGE050RN 37
- SGE050TLL 38
- SGE100RN 37
- SGE100TLL 38
- SGE250TLL 38
- solvents 2
- sound 22
- specifications 42
- stall 41
- stalled pump 16
- syringe calibration 16
- syringe, choosing 11
- syringe clamps 8
- syringe parameters 19
- syringes
 - 2, 10, 11, 13, 37
- syringe selection 31
- Syringe Stop Definition
 - screen 17, 18
- syringe stroke length 14
- syringe travel limits 17
- syringe types 13
- System Options screen 22

T

- Teflon tip 44
- travel limits 15
- troubleshooting 40

U

- UMP3 39
- UMP3 description 8
- unpacking 4

V

- volume 31
- volume counter 21, 31
- volume target 19

W

- withdraw 28

WARRANTY

WPI (World Precision Instruments, Inc.) warrants to the original purchaser that this equipment, including its components and parts, shall be free from defects in material and workmanship for a period of one year* from the date of receipt. WPI's obligation under this warranty shall be limited to repair or replacement, at WPI's option, of the equipment or defective components or parts upon receipt thereof f.o.b. WPI, Sarasota, Florida U.S.A. Return of a repaired instrument shall be f.o.b. Sarasota.

The above warranty is contingent upon normal usage and does not cover products which have been modified without WPI's approval or which have been subjected to unusual physical or electrical stress or on which the original identification marks have been removed or altered. The above warranty will not apply if adjustment, repair or parts replacement is required because of accident, neglect, misuse, failure of electric power, air conditioning, humidity control, or causes other than normal and ordinary usage.

To the extent that any of its equipment is furnished by a manufacturer other than WPI, the foregoing warranty shall be applicable only to the extent of the warranty furnished by such other manufacturer. This warranty will not apply to appearance terms, such as knobs, handles, dials or the like.

WPI makes no warranty of any kind, express or implied or statutory, including without limitation any warranties of merchantability and/or fitness for a particular purpose. WPI shall not be liable for any damages, whether direct, indirect, special or consequential arising from a failure of this product to operate in the manner desired by the user. WPI shall not be liable for any damage to data or property that may be caused directly or indirectly by use of this product.

Claims and Returns

Inspect all shipments upon receipt. Missing cartons or obvious damage to cartons should be noted on the delivery receipt before signing. Concealed loss or damage should be reported at once to the carrier and an inspection requested. All claims for shortage or damage must be made within ten (10) days after receipt of shipment. Claims for lost shipments must be made within thirty (30) days of receipt of invoice or other notification of shipment. Please save damaged or pilfered cartons until claim is settled. In some instances, photographic documentation may be required. Some items are time-sensitive; WPI assumes no extended warranty or any liability for use beyond the date specified on the container

Do not return any goods to us without obtaining prior approval and instructions from our Returns Department. Goods returned (unauthorized) by collect freight may be refused. Goods accepted for restocking will be exchanged or credited to your WPI account. Goods returned which were ordered by customers in error are subject to a 25% restocking charge. Equipment which was built as a special order cannot be returned.

Repairs

Contact our Customer Service Department for assistance in the repair of apparatus. Do not return goods until instructions have been received. Returned items must be securely packed to prevent further damage in transit. The Customer is responsible for paying shipping expenses, including adequate insurance on all items returned for repairs. Identification of the item(s) by model number, name, as well as complete description of the difficulties experienced should be written on the repair purchase order and on a tag attached to the item.

** Electrodes, batteries and other consumable parts are warranted for 30 days only from the date on which the customer receives these items.*



WORLD
PRECISION
INSTRUMENTS